



Disclaimer, warranties and limitation of liability

This publication is intended to be an aid for all trades and professionals involved with specifying and installing LYSAGHT products and not to be a substitute for professional judgement.

Terms and conditions of sale available at local BlueScope Lysaght sales offices.

Except to the extent to which liability may not lawfully be excluded or limited, BlueScope Steel Limited will not be under or incur any liability to you for any direct or indirect loss or damage (including, without limitation, consequential loss or damage such as loss of profit or anticipated profit, loss of use, damage to goodwill and loss due to delay) however caused (including, without limitation, breach of contract, negligence and/or breach of statute), which you may suffer or incur in connection with this publication.

© Copyright BlueScope Steel Limited 15 December, 2009



Accessory sheet

NSW	Vic.	Qld	SA & NT	WA	Tas.
BMT 0.55	BMT 0.55 ZL, GB, CB	BMT 0.40 & 0.55	BMT 0.55	BMT 0.40-&-0.55	BMT 0.55 • ZL
Materials • ZL • Single-sided CB with strippable coating	Dimensions 1800 x 900 1800 x 1200 2400 x 900 2400 x 1200	Materials ZL, CB, GB & stainless	Materials GB, ZL & CB	Materials • ZL • GB • Single-sided CB	• Single-sided CB with strippable coating • AQUAPLATE CB
Dimensions 2400 x 1200		Dimensions 2400 x 1200	Dimensions To order	Dimensions 2400 x 1200	Dimensions 2400 x 1200

Flat strips (hoop iron)

Materials	Dimensions & lengths			
Qld: ZL or GB WA: GB	0.4 x 25 & 0.4 x 38 1800 & 2400	0.6 x 25 & 0.6 x 38 1800 & 2400	0.8 x 25 2400	1.0 x 25 2400



Strapping (coils)

NSW	Vic.	Qld	SA	NT	Tas.
25 x 1.0 x 100m	32 x 1.2 x 100m	30 x 1.0 x 30m	25 x 0.6 x 100m 51 x 1.6 x 25m	25 x 0.6	25 x 1.0 25 x 1.2 25 x 1.6
32 x 1.0 x 100m 32 x 1.2 x 100m 32 x 1.6 x 100m	38 x 1.2 x 100m 38 x 1.6 x 100m	32 x 1.2 x 50m 32 x 1.2 x 25m		51 x 1.6 x 25m	32 x 1.2 32 x 1.6
38 x 1.2 x 50m		51 x 1.6 x 25m			38 x 1.2 38 x 1.6
51 x 1.6 x 25m					51 x 1.6



LYSAGHT

Silicone sealant

Colours

Neutral cure.
Clear, grey &
other colours.
Clear & grey only
in NSW, SA & Qld.
Only clear in Vic.

Sizes

Single tubes
(Cartons of 20
tubes in some
centres)



Soft zinc flashing

This material is ZL & CB compatible

Thickness

0.7 mm

Length

6 metre rolls

Widths

110, 150, 230, 300,
380, 460, 580 mm



Tools (turn-up/turn-down) & notching tools

Not all tools
are available in
all areas. Refer
to your local
service office
for availability.

CUSTOM ORB

Speednotcher

INTEGRITY 820

(Qld only)
Turn up
Turn down
Speednotcher

KLIP-LOK 700 HS

Turn up
Turn down
Speednotcher

SPANDEK

Turn up
Speednotcher

TRIMDEK

Turn up
Turn down
Speednotcher

LONGLINE 305

Turn up/down
Speednotcher
Button punch
Rib closing tool
End-lap tool

KLIP-LOK 406

(NSW only)
Turn up
Turn down
Speednotcher



Abbreviations	
CB	= COLORBOND® colours on ZINCALUME® steel
CU	= Copper unpainted
GB	= GALVABOND® steel unpainted
SS	= Stainless steel unpainted
ZL	= ZINCALUME® steel unpainted
All measurements are millimetres	



Ventilated ridges

All ventilator ridges are custom made to order

NSW	Vic	Qld	SA & NT	WA	Tasmania
Materials ZL, CB	Materials ZL, CB, GB, Cu, SS	Materials ZL, CB	Materials ZL, CB	Materials ZL, CB, ULTRA & SS	Materials ZL, CB
Throat sizes 300 350 400 450 500 550 600	Throat sizes 150 225 300 Stop ends Supplied loose. Closed top Open top	Throat sizes MX series: custom made up to 900 mm TC series: custom made up to 600 mm MX series TC series Stop ends Supplied loose.	Throat sizes 125 150 200 250 300 350 450 600 Stop ends Supplied loose or fitted.	Throat sizes 150, 200, 300, 400 & 600 Standard Ranceline Also available as Slope vents for fitting to face of roof. Options • Dampers • Heavy duty brackets • Stop ends • Bird-proofing	Throat sizes 125 150 225 300 Stop ends Supplied loose or fitted.

Supplied unassembled.

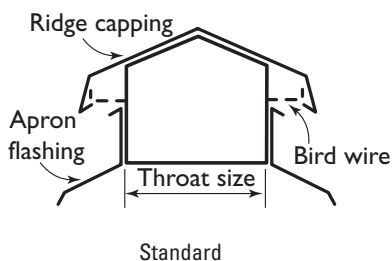

Standard

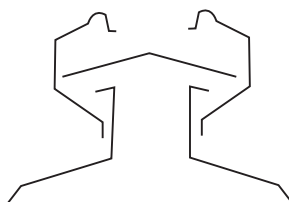

Ranceline

WA ventilator ridges

Slope vents are supplied assembled; others are usually knocked-down.

For quote or order state:

1. Type
2. Throat size
3. Material
4. Roof pitch
5. Roof profile
6. Number of stop ends
7. Bird-proofing
8. Dampers



Louvres

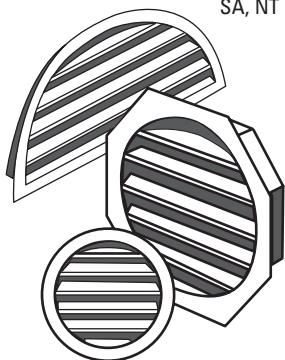

Available
SA, NT & WA

Material
0.6 mm GB

Finish
Powdercoating
CB.

In WA: ZL, CB, ULTRA, SS
Ask about non-standard sizes and shapes (including triangular)

Sizes
Round
340 mm dia
620 mm dia
Ask for non-standard sizes

Sizes
Half-round
900 x 500
Ask for non-standard sizes

Sizes
Octagonal
620 mm dia
Ask for non-standard sizes
Square & Rectangular
Also available in SA
Ask for non-standard sizes



Box gutter brackets

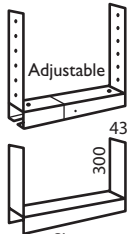

Sizes:
350/400
400/650
650/1000

Vic & NSW

Construction
Adjustable

Materials
ZL

Width
Size 1: 250-400
Size 2: 400-650
Size 3: 650-1000

Qld

Construction
Spot welded & adjustable

Materials
ZL

Width
Up to and including:
Size 1: 250-400
Size 2: 400-650
Size 3: 650-1000

SA & NT
(Called straps & saddles)
Adjustable

Materials
ZL

Width
Size 1: 250-400
Size 2: 400-650
Size 3: 700-1000

WA
Called
Adjustable straps & saddles

Materials
ZL

Width
Small: 250-400
Medium: 400-650
Large:
+650-1000

Box gutter sumps

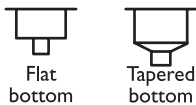

Vic & NSW

Materials
ZL & CB

Size
Custom made to order

Qld

Materials
GB, ZL & CB

Sizes
Custom made to order
All 150 deep
200 x 200
300 x 300
400 x 400
450 x 450
500 x 500
550 x 550
600 x 600

SA & NT

Materials
ZL, CB & GB

Sizes
Any size to order

WA

Materials
ZL & CB

Sizes
250 x 250 x 100
300 x 225 x 225
300 x 300 x 250
375 x 225 x 225
375 x 225 x 225
450 x 300 x 300
600 x 600 x 100
Ask about non-standard



Box gutter expansion joints



Qld, WA & NSW
Custom made to your drawing.

Materials
ZL & CB

Lengths
Up to 400mm
Over 400mm

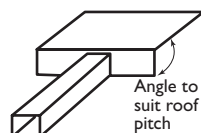

Abbreviations	
CB	= COLORBOND® colours on ZINCALUME® steel
CU	= Copper unpainted
GB	= GALVABOND® steel unpainted
SS	= Stainless steel unpainted
ZL	= ZINCALUME® steel unpainted
All measurements are millimetres	

Rainwater heads

NSW

Refer to the Service Offer for details.

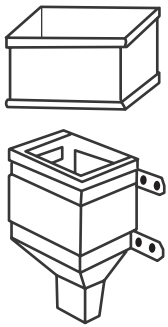

Vic

Materials
ZL & CB

Sizes
Custom made to order

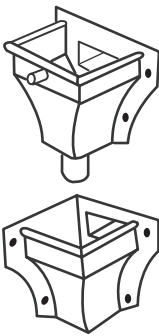

Qld

Materials
GB, ZL & CB

Sizes
Custom made to order



Round rainwater heads custom made to order

Contact SA branch for details on the full rainwater head range.

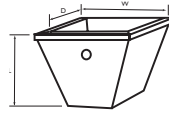

Ornamental Rainhead

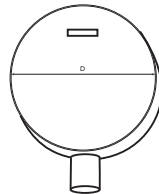

Full Moon Rainhead

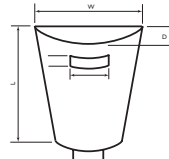

Tapered Bushranger Rainhead

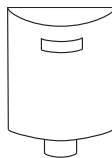

Bushranger Rainhead

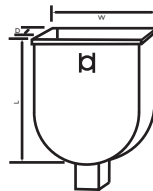

Tulip Rainhead

SA & NT

Materials
ZL, GB & CB

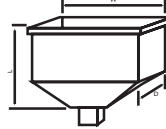

Tapered Classic Rainhead

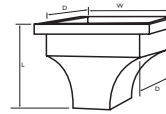

Antique Rainhead

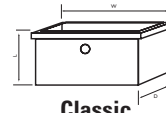

Classic Rainhead

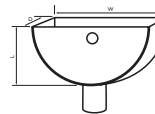

Half Moon Rainhead

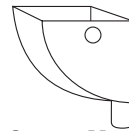

Quarter Moon Rainhead

WA

Materials
ZL, GB & CB

Sizes

Flat bottom
300 x 750 x 150
375 x 225 x 225
600 x 300 x 300

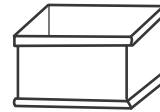

Tapered bottom
250 x 200
300 x 200
400 x 250
450 x 300
600 x 450

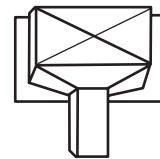

CB Ultra & metallic, Copper and Stainless are subject to enquiry.

Generally, trade work can be manufactured to client's detailed drawings.

Transitions, roof collars & overflows

Queensland

Materials
ZL & CB

Sizes
Custom made to order

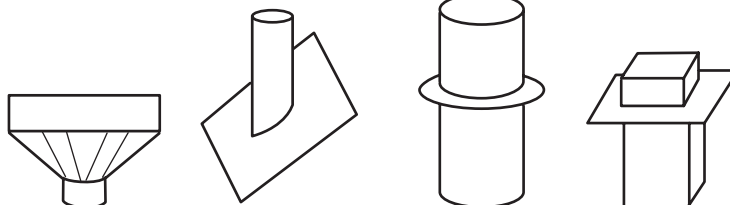

Fixed metal louvres

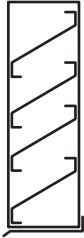

**Queensland
NSW and W.A.**

Materials
ZL, GB & CB

Sizes
Qld: 1200 (H) x
900 (W) x 75 (D)

NSW & WA:
Custom made
to order.



Translucent sheeting (Contact local branch for availability)

CUSTOM ORB
(Polycarbonate
& fibreglass)



FLATDEK
(Fibreglass)



KLIP-LOK 406
(Fibreglass)

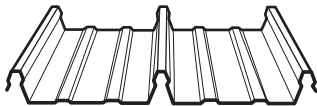

KLIP-LOK 700
(Fibreglass)

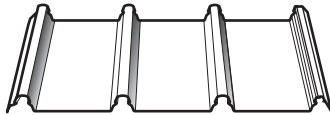

SPANDEK
(Fibreglass)



TRIMDEK
(Polycarbonate
& fibreglass)



GRECA
(Polycarbonate)



KLIP-LOK MAXIMA
(Fibreglass)

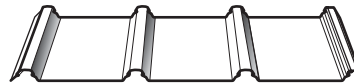

(WA only, 770 mm wide)



Materials
Fibreglass
2400 g/m²
(1800 g/m² & 3050 g/m² subject to
enquiry)

Colours
Polycarbonate
Clear, Opal, bronze & grey
(Other colours subject to enquiry.)

Fibreglass
CUSTOM ORB & TRIMDEK:
clear and opal.
All other profiles: clear & opal.
(Other colours subject to enquiry.)

Lengths
Polycarbonate
1800, 2400, 3000, 3600, 4200, 4800, 5400,
6000, 7200

Fibreglass
900 to 12200
(Other lengths subject to enquiry.)

Fastening
All screws should have 32mm
Weatherlok® washers.

Weatherlok® is a registered
trademark of ITW Buildex.

Abbreviations	
CB	= COLORBOND® colours on ZINCALUME® steel
CU	= Copper unpainted
GB	= GALVABOND® steel unpainted
SS	= Stainless steel unpainted
ZL	= ZINCALUME® steel unpainted
All measurements are millimetres	

Weatherlok washers

For use under the head of fasteners fixing translucent sheeting.
(Allow 10mm extra length for screws.)



Diameter
20
32

Lapseal

Lapseal is a tape for sealing and weatherproofing placed under translucent sheeting, on top of purlins, to prevent cracking noises from expansion.



Width
50
75
100

Thickness
6 mm

Length
11.7 metres



Ant caps



Queensland & WA



Queensland only

Qld

Materials
ZL & CB

Sizes square

200 x 200
225 x 225
250 x 250
300 x 300

Sizes round

200 diameter
250 diameter
300 diameter

WA

Materials
ZL & CB

Sizes

Square only
100 x 100
225 x 225



Dektite® pipe flashings

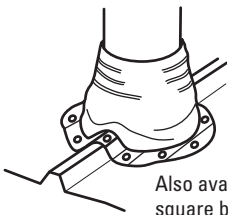

Also available in square base subject to enquiry.

Available in EPDM (Red, black or grey in WA, Black or grey in NSW)
Retrofit type also available subject to enquiry.

Refer to your Region's service offer for sizes, shapes and availability.
Dektite® is a registered trademark of Dek Industries Pty Ltd.



Roof infill strips (closed cell type)

Except for CUSTOM ORB and SPANDEK, specify top or bottom.



CUSTOM ORB profile shown

	Length
CUSTOM ORB	915
TRIMDEK	915
SPANDEK	760
KLIP-LOK 406	810
KLIP-LOK 700HS	730
KLIP-LOK MAXIMA	770
INTEGRITY 820	890
FLATDEK	roll
FLATDEK II	roll

Width
All profiles
20

We also have infills for FLATDEK and FLATDEK II, but these are in rolls.



Safety mesh

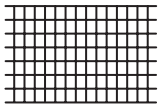

Complies with
AS4389:1996

Minimum
thickness 2.0mm

Mesh
100 x 115 x 1.25

Roll width
1800

Roll length
50 metres

Roll area
90 m²
Called Insulmesh
in SA

Mesh
150 x 150 x 1.6

Roll width
1800

Roll length
50 metres

Roll area
90 m²
N/A in SA.

Mesh
150 x 300 x 2

Roll width
1800

Roll length
50 metres

Roll area
90 m²
Called Roofsafe
or roofing wire in
SA, Safety mesh in
Qld, NSW & WA.

Mesh
150 x 300 x 3.15

Roll width
900

Roll length
60 metres

Roll area
54 m²
N/A in SA.

Ventilators: Industrial & Domestic

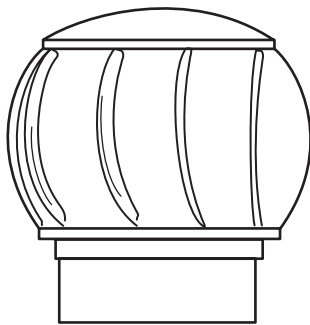
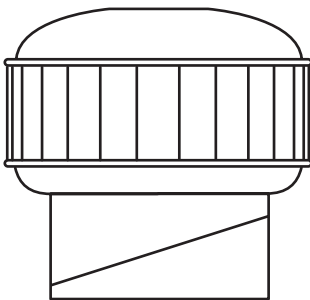

Wind-driven ventilators
Models and sizes vary from region to region. Enquire on product availability from your local service centre.

Material
Aluminium

Finish
Most
COLORBOND®
steel colours

Throat diameters
Model number usually indicates diameter in mm

Options
Include electrically-controlled dampers



Fasteners: Screw to steel—AS3566 Class 4 (except as noted)

Refer to regional product offers for details of all available fasteners. Selection on these pages is an indicative but not comprehensive selection. Class 3 fasteners not available in Queensland. All other states, refer to local office for availability.

Most fasteners, except those zinc plated, are available powder-coated to match COLORBOND® steel colours.

Refer to AS3566 Class 4 Fasteners used should be BlueScope Lysaght approved.

Fasteners we recommend for our products are specified in our individual product publications.

Coating Class 4

Gauge	TPI	Length (mm)
-------	-----	-------------

Self drilling screw for thin gauge steel (with underwasher thread) with seal



13	13	41
13	13	55
15	15	55

Hex. head Self drilling screw with seal (part thread)



14	10	42
14	10	50
14	10	65

Stitching screws

Hex. head with seal



10	12	20
----	----	----

Hex. head with 19 mm aluminium bonded washer



14	10	42
14	10	50
14	10	65

Coating Class 4

Gauge	TPI	Length (mm)
-------	-----	-------------

Roofzips® Hex. head self drilling screw for steel (with underwasher thread) with seal



12(M6)	11	50mm
--------	----	------

Hex. head self drilling screw for steel (with underwasher thread) with seal



12	14	35
12	14	45
12	14	68

Hex. head self drilling screw for steel (with underwasher thread) with seal (full thread)



10	16	16
12	14	20
14	10	42

Hex. head, no seal

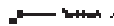

10	16	16
10	16	25
12	14	55
12	14	65
12	14	75
14	20	22
14	10	25
14	10	42
14	10	50

Hex. head with 19mm aluminium bonded washer



14	10	42
14	10	50
14	10	65

Self drilling screw with 19mm aluminium bonded washer



15	15	47
----	----	----

Zinc plated

Gauge	TPI	Length
-------	-----	--------

Wafer head

10	16	16
10	16	22



Hex. head, no seal



8	18	12
10	16	16

Coating Class 3 coated

Gauge	TPI	Length
-------	-----	--------

Wafer head



10	16	16
10	16	22

Ripple Teks®



10	16	20
10	16	30

Ripple Teks® and Roofzips® are registered trademarks of ITW Buildex.

Fasteners: Screw to timber

Refer to New South Wales for details of available fasteners. Class 3 fasteners not available in Queensland. All other states, refer to local office.

All fasteners, except those zinc plated, are available powder-coated to match COLORBOND® colours.

Coating class 3 coated

Gauge TPI Length

Hex. head with thread under washer with seal



12	11	50
12	11	65

Hex. head with seal (full thread)



10	12	25
12	11	25
14	10	25

Hex. head with seal (part thread)



12	11	45
14	10	50
14	10	65

Hex. head no seal (full thread)



10	12	25
12	10	25
14	10	25

Hex. head, no seal (part thread)



12	11	45
12	11	50
14	10	50
14	10	65

Ripple Tek® screws (30 mm) are used for fixing MINI ORB to timber — see previous page for sizes.

Coating class 3 coatings are to AS 3566 class 3. Coating class 4 coatings are to AS 3566 class 4.

Coating class 4 coated

Gauge TPI Length

Roofzips® Hex. head Self drilling screw for steel or timber (with underwasher thread) with seal

12(M6)	11	50mm
--------	----	------

Hex. head with thread under washer with seal



12	11	65
----	----	----

Hex. head with seal



12	11	25
14	10	25
14	10	50
14	10	65
14	10	75
14	10	90

Hex. head, no seal (N/A in Queensland)



12	11	25
14	10	25
14	10	50
14	10	65

Hex. head with 16 mm aluminium bonded washer



14	10	50
14	10	65

Hex. head with 19 mm aluminium bonded washer



14	10	50
14	10	65

Hex. head with 25 mm aluminium bonded washer



14	10	50
14	10	65

Across flats Length

Phillips drive bits #2

50

Fasteners we recommend for our products are specified in our product publications.

Zinc plated

Gauge TPI Length

Wafer head



10	12	25
10	12	45

Countersunk head (N/A in Queensland)



6	18	25
---	----	----

Bugle head batten

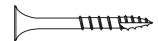

14	10	75
14	10	100

Fastener drive tools

Across flats Length

Hexagon sockets

5/16 inch	45
5/16 inch	65
3/8 inch	65



Length

Magnetic bit holder

75





Fasteners: Cyclonic assemblies—Screw to steel

For fixing without cyclonic assemblies, see LYSAGHT Cyclonic Design Manual. Cyclonic assemblies are available in WA, NT and Qld.

Coating class 4 coated

Gauge	TPI	Length
-------	-----	--------

For CUSTOM ORB

14	10	42
----	----	----



For SPANDEK & TRIMDEK

14	10	50
----	----	----



For KLIP-LOK 406 HIGH WIND

14	10	65
----	----	----



Coating class 4 coated

Gauge	TPI	Length
-------	-----	--------

Metal Batten Tek[®]
for CUSTOM ORB

15	15	47
----	----	----



Metal Batten Tek[®]
for SPANDEK & TRIMDEK

15	15	55
----	----	----



Metal Batten Tek[®]
for KLIP-LOK 406 HIGH WIND

15	15	47
----	----	----



Coating class 3 or 4 coated

Gauge	TPI	Length
-------	-----	--------

KLIP-LOK-700HS clip fixed to steel (0.75 - 1.0mm)

12	14	20
----	----	----

Hex. head no seal washer.

KLIP-LOK-700HS clip fixed to steel (1.0 - 3.0mm)

12	14	20
----	----	----

Hex. head no seal washer.



Fasteners: Cyclonic assemblies—Screw to timber

Available in WA, NT and Qld only.

Coating class 4 coated

Gauge	TPI	Length
-------	-----	--------

Hex. head for
CUSTOM ORB

14	10	50	HARDWOOD
14	10	65	SOFTWOOD



Hex. head for
SPANDEK & TRIMDEK

14	10	65	HARDWOOD
14	10	75	SOFTWOOD



Hex. head for
KLIP-LOK 406 HIGH WIND

14	10	75	HARDWOOD
14	10	90	SOFTWOOD



Coating class 3 or 4 coated

Gauge	TPI	Length
-------	-----	--------

KLIP-LOK-700HS clip fixed to timber - Type 17

Hex. Head

12	11	25	HARDWOOD
12	11	40	SOFTWOOD

Fasteners: Nails to timber

Refer to your local region's Service Offer for details of available fasteners.

Galvanised spiral-threaded steel nail



3.75 diameter x 40 long	HARDWOOD
3.75 diameter x 60 long	SOFTWOOD

Fasteners: Blind rivets

Refer to your local region's Service Offer for details of available fasteners.

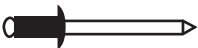

Body	Mandrel	Dia.	Grip	Type	Head
Aluminium	Steel	3.2	8	Plain	Button



Insulation: Reflective foil laminate

Refer to New South Wales or Queensland Service Offer for details. All other states, refer to local sales office.

Lightweight

Plain facing

1350 x 20 m (27 m²)
1350 x 60 m (81 m²)

Anti-glare facing

1350 x 20 m (27 m²)
1350 x 30 m (40.5 m²)
1350 x 60 m (81 m²)

Building grade—Anti-glare

1350 x 20 m (27 m²)
1350 x 60 m (81 m²)

Mediumweight

Plain facing

1350 x 20 m (27 m²)
1200 x 60 m (72 m²)
1350 x 60 m (81 m²)

Anti-glare facing

1350 x 20 m (27 m²)
1350 x 30 m (40.5 m²)
1350 x 60 m (81 m²)

Perforated

1350 x 60 m (81 m²)

Sisaltuff

1350 x 60 m (81 m²)

Heavyweight

Plain facing

1350 x 20 m (27 m²)
1200 x 60 m (72 m²)
1350 x 60 m (81 m²)

Anti-glare facing

1350 x 20 m (27 m²)
1350 x 30 m (40.5 m²)
1350 x 60 m (81 m²)

Perforated

1350 x 60 m (81 m²)

Gladiator wallwrap

1350 x 60 m (81 m²)

Thermotuff wallwrap

1350 x 60 m (81 m²)

Insulation: Building blanket with foil

Lightweight foil facing

R1.5 1200 x 15 m (18 m²)
R1.5 1200 x 20 m (24 m²)

R2.0 1200 x 10 m (12 m²)
R2.0 1200 x 15 m (18 m²)

R2.5 1200 x 10 m (12 m²)

Mediumweight foil facing

R1.5 1200 x 15 m (18 m²)
R1.5 1200 x 20 m (24 m²)

R2.0 1200 x 10 m (12 m²)
R2.0 1200 x 15 m (18 m²)

R2.5 1200 x 10 m (12 m²)

Heavyweight foil facing

R1.5 1200 x 15 m (18 m²)
R1.5 1200 x 20 m (24 m²)

R2.0 1200 x 10 m (12 m²)
R2.0 1200 x 15 m (18 m²)

R2.5 1200 x 10 m (12 m²)
R2.5 1200 x 7.5 m (9 m²)

Insulation: Building blanket

Lightweight

R1.2 1200 x 15 m (18 m²)
R1.2 1200 x 20 m (24 m²)
R1.2 1200 x 30 m (36 m²)

R1.8 1200 x 10 m (12 m²)
R1.8 1200 x 15 m (18 m²)
R1.8 1200 x 20 m (24 m²)

R2.3 1200 x 10 m (12 m²)
75 mm 1200 x 20 m (24 m²)

Mediumweight

R1.5 1200 x 15 m (18 m²)
R1.5 1200 x 20 m (24 m²)

R2.0 1200 x 10 m (12 m²)
R2.0 1200 x 15 m (18 m²)

R2.5 1200 x 10 m (12 m²)

Heavyweight

R1.5 1200 x 15 m (18 m²)
R1.5 1200 x 20 m (24 m²)

R2.0 1200 x 10 m (12 m²)
R2.0 1200 x 15 m (18 m²)

R2.5 1200 x 10 m (12 m²)
R2.5 1200 x 7.5 m (9 m²)

Insulation: Ceiling batts

R2.0 1160 x 430 16 per pack (8 m²)
R2.0 1160 x 580 16 per pack (10.8 m²)

R2.5 1160 x 430 16 per pack (8 m²)
R2.5 1160 x 580 16 per pack (10.8 m²)

R3.0 1160 x 580 16 per pack (10.8 m²)

Insulation: Wall batts

R2.0 1160 x 430 16 per pack (8 m²)
R2.0 1160 x 580 16 per pack (10.8 m²)
R1.5 1170 x 430 30 per pack (15 m²)
R1.5 1170 x 580 26 per pack (17.5 m²)
R2.0 1160 x 580 8 per pack (5 m²)

Insulation: Foil Tape

Reinforced foil, 48 mm wide